

HÖRMANN

RESIDENTIAL DOOR OVERVIEW

For Life. For Life. For Life. For Life.
For Life. For Life. For Life. For Life.
For Life. For Life. For Life. For Life.

Residential Pan Door Products

Steel Doors

Superior Quality with Unmatched Value

Pro Tech 2500

Residential Steel Pan Door

VALUE		
Door: Ltd Lifetime	Hardware: 2 yr	Springs: 3 yr

- R-7.4 with opt. Insulation
- Steel Front
- 2" Sections
- 12 Colors
- 5 Panel Designs
- 26 Window Designs

Thermal Rating	
Customizations	
Low Maintenance	
Luxury Level	

PANEL DESIGN OPTIONS

1 Short Raised (Traditional)	2 Long Raised (Ranch)	3 Country
4 Cottage	5 Shaker	

*Medley designs available

COLOR OPTIONS

1	2	3	4
5	6	7	8
9	10	11	12

1 White	6 Teratone
2 Sandstone	7 Hunter Green
3 Almond	8 Black
4 Desert Tan	9 Golden Oak
5 Brown	10 Medium Oak
Color application method will be at the discretion of the manufacturer.	
	11 Walnut
	12 Rosewood

All colors shown as accurately as printing technology allows.



Sophisticated Engineering, Many Options

Therma Tech 3400

Residential Sandwich Door

BETTER

Door: Ltd Lifetime Hardware: 3 yr Springs: 3 yr

- R-9.0 Thermal Rating
- Steel Front and Back
- 1½" Sections
- 12 Colors
- 7 Panel Designs
- 26 Window Designs

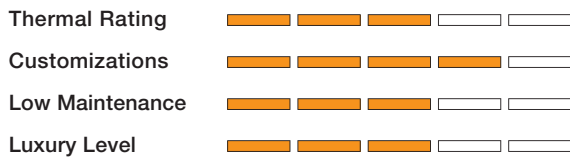

COLOR OPTIONS



1 White	6 Teratone
2 Sandstone	7 Black
3 Almond	8 Hunter Green
4 Desert Tan	9 Golden Oak
5 Brown	10 Medium Oak
Color application method will be at the discretion of the manufacturer.	
	11 Walnut
	12 Rosewood

All colors shown as accurately as printing technology allows.

PANEL DESIGN OPTIONS

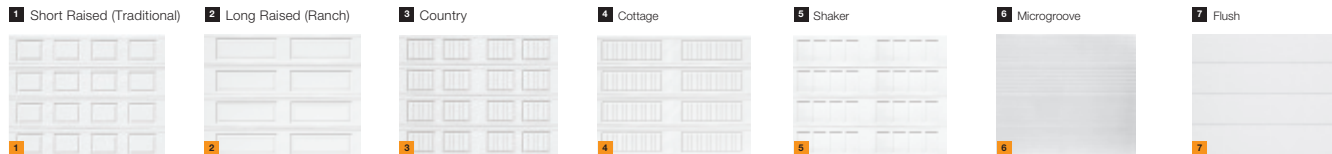

*Medley designs available



Residential Polyurethane Products

Clima Tech 4400 - 1-1/2" Door

Industry-Leading Insulation and Strength

Clima Tech 4400

BEST

 Door: Ltd Lifetime
  Hardware: 4 yr
  Springs: 3 yr

- **R-15.7** Thermal Rating
- Steel Front and Back
- 1-1/2" Sections
- 5 Colors + Custom Color
- 6 Panel Designs
- 26 Window Designs

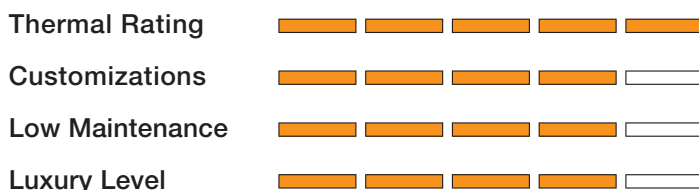



★ Color Match Any Color in the Galaxy

★ Cost-Effective

★ More Durable Than Field Painting

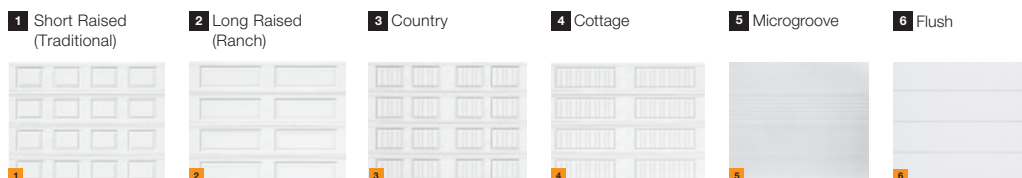
PANEL DESIGN OPTIONS



Residential Polyurethane Products

Clima Tech 4400 - 1-1/2" Door

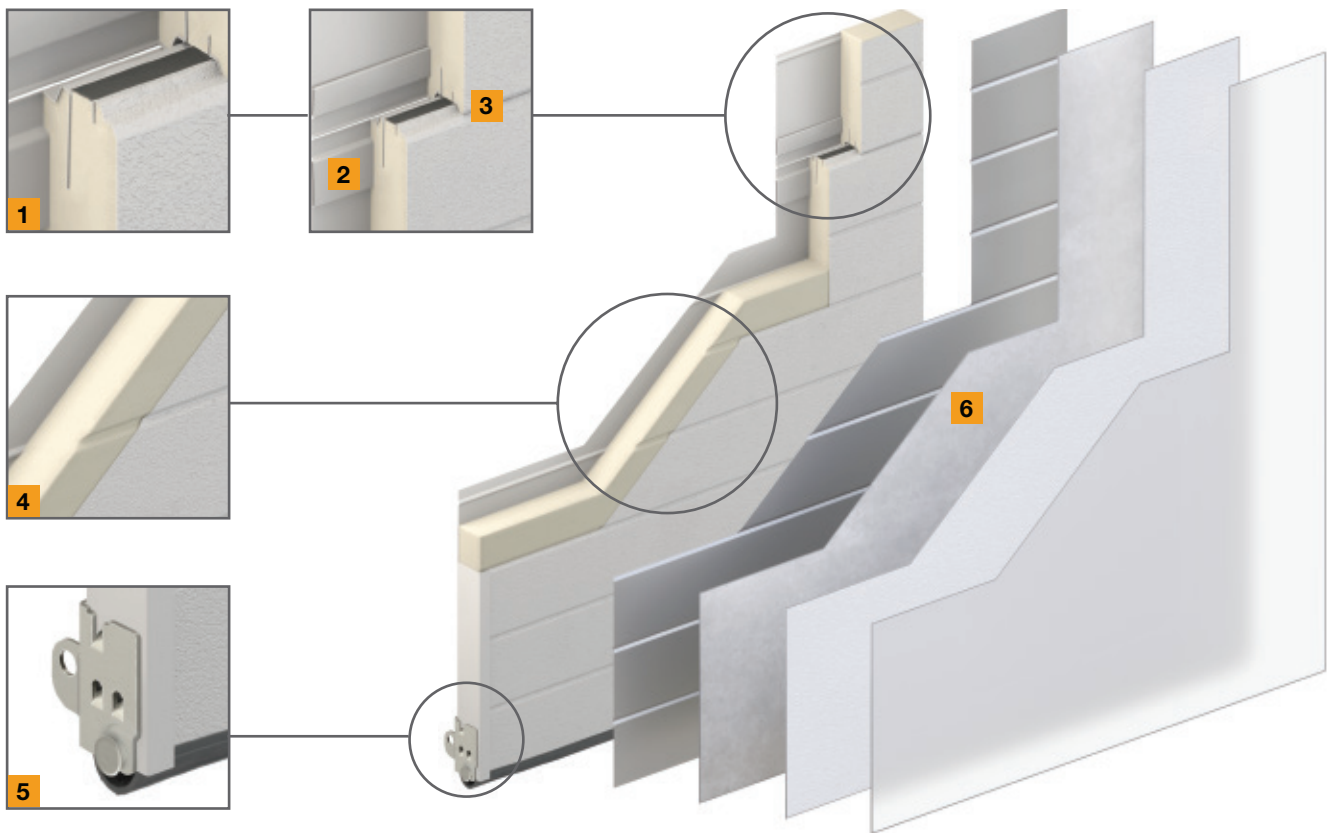

Precise Thermal Break **1**

Increased thermal efficiency is achieved by our conduction-resistant thermal break.

Reinforced Mounting Steel **2**

Triple-reinforced steel fold extends across the entire section for robust hardware mounting. An internal steel layer creates additional stability.

Insulated Tongue & Groove **3**

Joints are sealed with insulating foam and joint tape to reduce air flow and heat loss.

Proprietary Urethane Blend **4**

Perfected over generations, our precisely engineered polyurethane outperforms competitors in strength, energy efficiency, and density every time.

Proprietary Safety Brackets **5**

Reinforced bottom brackets and red safety screws create a double layer of built-in protection.

Residential Carriage Style Products

Steel and Aluminum Doors

Solid Steel or Aluminum Construction with a Timeless Look

Infinity Classic 7800

Premium Residential Aluminum Carriage House Door

BEST

Door: Ltd Lifetime
 Hardware: 7 yr
 Springs: 3 yr

- **R-5.6** With Opt. Insulation
- Aluminum
- 2" Sections
- Look of Real Wood
- 70+ Designs Available
- Extremely Easy to Maintain

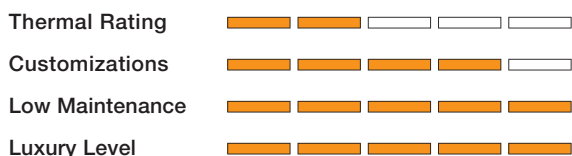

Therma Style 5500

Residential Steel Carriage House Door

VALUE

Door: Ltd Lifetime
 Hardware: 5 yr
 Springs: 3 yr

- **R-10.4**
- Steel Front and Back
- 2" Sections
- Standard White Color
- 60+ Designs Available
- May Be Field Painted

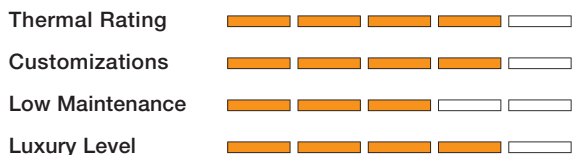



Residential Carriage Style Products

Clima Elite 5800 - 2" Door

Clima Elite 5800

NEW

BEST

 Door: Ltd Lifetime
  Hardware: 5 yr
  Springs: 3 yr

- R-15.7 Thermal Rating
- Steel Construction
- 2" Door
- White (Field Paint Option)
- 144 Panel + Window Designs
- 1-1/2" Polyurethane Insulation

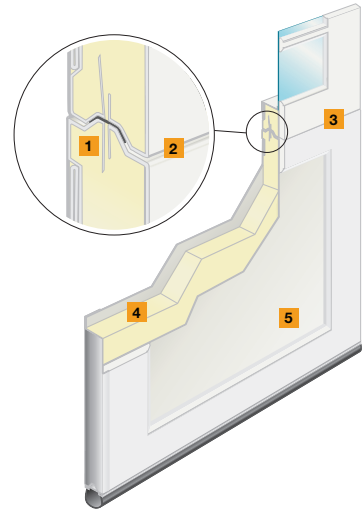
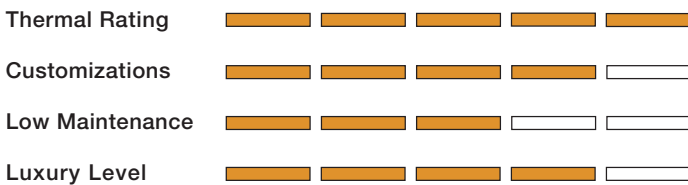

GLASS OPTIONS



- 1 Clear
- 2 Bronze
- 3 Satin Etch
- 4 Gluechip
- 5 Privacy
- 6 Mistlite
- 7 Obscure
- 8 Gray

*Glass Options are available in uninsulated or insulated variants

Precise Thermal Break ¹
Increased thermal efficiency is achieved by our conduction-resistant thermal break.

Insulated Tongue & Groove ²
Our joints are sealed with insulating foam and joint tape to reduce air flow and heat loss.

Custom Overlays on Polyurethane Insulated Panels ³
Weather-resistant, custom-machined Extrira overlay material enables multitudes of design options along with the beauty of recessed window placement. Triple-reinforced steel extends across the entire section for robust hardware mounting. An internal steel layer creates additional stability.

Proprietary Urethane Blend ⁴
Perfecting over generations, our precisely-engineered polyurethane outperforms its competitors in strength, energy efficiency, and density every time.



Residential Pinch Resistant Products

Steel and Aluminum Doors

Precision Engineering and Maximum Safety

Pro Safe 2100

Residential Steel Pan Door

VALUE

Door: Ltd Lifetime
 Hardware: 3 yr
 Springs: 3 yr

- **R-7.4** with opt. Insulation
- Steel Front
- 2" Sections
- 12 Colors
- 4 Panel Designs
- 26 Window Designs

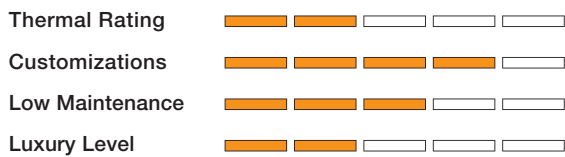

Therma Safe 3200

Residential Steel Sandwich Door

BETTER

Door: Ltd Lifetime
 Hardware: 4 yr
 Springs: 3 yr

- **R-9.0** Thermal Rating
- Steel Front and Back
- 2" Sections
- 12 Colors
- 6 Panel Designs
- 26 Window Designs

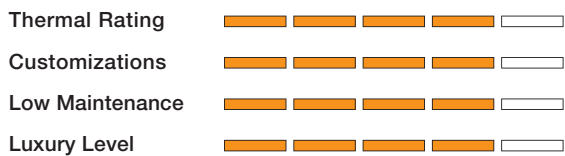

Residential Pinch Resistant Products



Steel and Aluminum Doors

European Standards and Superior Style

Style Safe 5200/5250

Residential Steel Carriage House Door

BETTER

 Door: Ltd Lifetime
  Hardware: 6 yr
  Springs: 3 yr

- **R-6.9**
- Steel Front and Back
- 2" Sections
- Standard White Color
- 6 Panel Options Available
- Galaxy Paint System Available

Thermal Rating 

Customizations 

Low Maintenance 



Luxury Level 



Classic Safe 7200

Residential Aluminum Full View Door

BEST

 Door: Ltd Lifetime
  Hardware: 8 yr
  Springs: 3 yr

- Anodized Aluminum
- Excellent Strength
- 1-3/4" Sections
- Multiple Glazing Options
- Panel Options Available
- Galaxy Paint System

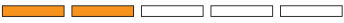
Thermal Rating 

Customizations 

Low Maintenance 

Luxury Level 



Residential Wood Products



Handcrafted Luxury

High-End, Handcrafted, and Elegant

Heritage C-Series

Sophisticated Wood Door

BEST

 Door: 1 yr
  Hardware: 5 yr
  Springs: 3 yr

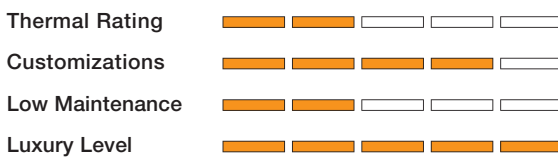

- **R-6.18**
- Natural Wood
- 2-7/8" Sections
- Various Wood Types Available
- 60+ Designs Available
- Many Glass Options



Heritage E-Series

Elegant Wood Door

BETTER

 Door: 1 yr
  Hardware: 5 yr
  Springs: 3 yr

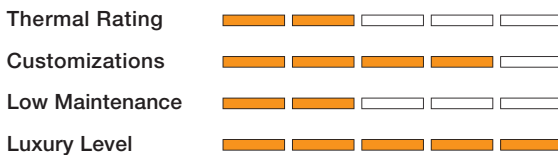

- **R-6.18**
- Natural Wood
- 2-1/4" Sections
- Elegant Wood Designs
- 70+ Designs Available
- Many Glass Options



Heritage Builder

Excellent Value Wood Door

VALUE

 Door: 1 yr
  Hardware: 5 yr
  Springs: 3 yr

- **R-6.18**
- Natural Wood
- 2-1/4" Sections
- Value Wood Door Option
- Standard Unfinished
- Many Glass Options

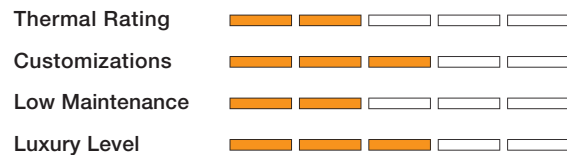

Doors for where we live and work

Hörmann. For Life.



LEARN
MORE



VISIT [HORMANN.US](https://www.hormann.us) FOR MORE INFORMATION
1-877-OK-HORMANN

HÖRMANN



Contemporary Style Products

Sleek and Modern Designs

Modern Tech 3550

BETTER

 Door: Ltd Lifetime
  Hardware: 3 yr
  Springs: 3 yr

- **R-10.4** Thermal Rating
- 24 ga. Smooth Steel
- 2" Sections
- 4 Colors
- 40+ Designs

Thermal Rating

Customizations

Low Maintenance

Luxury Level

COLOR OPTIONS

1 White 2 Black Satin
 3 Dark Bronze 4 Graphite

GLASS OPTIONS

1 Clear 2 Bronze 3 Satin Etch 4 Gluechip
 5 Privacy 6 Mistlite 7 Obscure 8 Gray

*Glass Options are available in both uninsulated or insulated variants



Contemporary Style Products

Sleek and Modern Designs

Modern Classic 7500

BEST

Door: Ltd Lifetime
 Hardware: 5 yr
 Springs: 3 yr

- Commercial Grade Aluminum
- 2" Thick Sections
- 9 Finish Colors
- 30 Panel + Window Designs

Thermal Rating

Customizations

Low Maintenance

Luxury Level

COLOR OPTIONS



GLASS OPTIONS



- 1 Clear
- 2 Privacy
- 3 Obscure
- 4 Bronze
- 5 Mistlite
- 6 Satin Etch
- 7 Frosted Gluechip
- 8 Black Laminated
- 9 White laminated

- 1 Clear Anodized
- 2 Dark Bronze Anodized
- 3 Black Anodized
- 4 White
- 5 Dark Cherry
- 6 Dark Fir
- 7 Mahogany
- 8 Dark Walnut
- 9 Italian Rosewood

*Glass Options are available in both uninsulated or insulated variants
 **Laminate glass options not available in insulated variant



DID
YOU
KNOW



1 ALL YOU NEED IS ONE
MANUFACTURER FOR
DOORS AND DOCKS.

From the edge of your dock and throughout your building, Hörmann is THE one-stop-shop for all your door and dock needs! We have the latest door technology available for any commercial, residential, or high-performance door project, and add in our comprehensive bundle of loading dock equipment for complete coverage from one source.

Commercial Sectional Products

Pan, Sandwich, and Polyurethane Doors

We Offer a Solution for Any Application

Hörmann's **state-of-the-art** production facilities empower us to produce the **highest quality** commercial sectional doors available today. Our products meet the demands of all types of industries, and come with a **wide array of customizations** and options. In addition to our original core product lines, we now offer industry-leading **polyurethane** insulated products **made in the heart of the USA.**



Commercial Tongue and Groove Products



255P / 254P / 250P

- 2" Sections
- Tongue & Groove Section Joints
- 25, 24, or 20 Gauge Steel
- Insulation Optional



440U

- 1-1/2" Sections
- Tongue & Groove Section Joints
- 25 Gauge Steel
- Polyurethane Insulation
- **R-Value:** 15.7



450U

- 2" Sections
- Tongue & Groove Section Joints
- 25 Gauge Steel
- Polyurethane Insulation
- **R-Value:** 18.4



340S / 350S / 354S

- 1-1/2" or 2" Sections
- Tongue & Groove Section Joints
- 25 or 24 Gauge Steel
- Polystyrene Insulation
- **R-Value:** 9.0 or 10.4

Commercial Pinch Resistant Products

225P / 224P

- Commercial Pan Door
- 2" Sections
- Non-insulated

325S / 324S

- 2" Sections
- Polystyrene Insulation
- **R-Value:** 8.9

425U

- 1-3/4" Sections
- Polyurethane Insulation
- **R-Value:** 16.1

720A

- 1-3/4" Sections
- Glazed Aluminum Sections
- Galaxy Paint System

HÖRMANN NORTH AMERICA



Sparta, TN - North American Headquarters / Sectional Doors

SIX PRODUCTION PLANTS, ONE FAMILY

As one of the world's leading manufacturers of door and dock systems, we're committed to providing the best quality, value, and selection. Whether residential, commercial or industrial, we have the solutions you're looking for. Each Hörmann product gives you the perfect array of benefits and options to satisfy your customers.

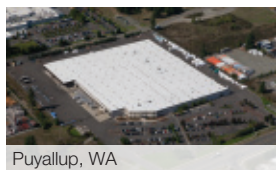

Puyallup, WA

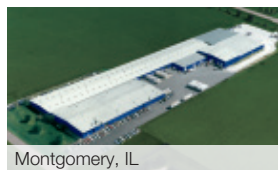

Montgomery, IL



Oro-Medonte, ON Canada



Burgettstown, PA



Imperial, PA

USA

Toll Free: 800.365.3667
Email: info@hormann.us
Website: hormann.us

Canada

Toll Free: 866.792.9968
Email: info@hormann.ca
Website: hormann.ca

Mexico

Toll Free: 52 (81) 8308 7481
Email: info@hormann.com.mx
Website: hormann.mx



AVAILABLE FROM:



PN 2775150

Follow us on social media



We reserve the right to change specifications without notice. ©Hörmann (Issue 5.2026)